

503-53-024H  
SRPAI&PD USBR  
DEED: 08474-0352 M.C.R.

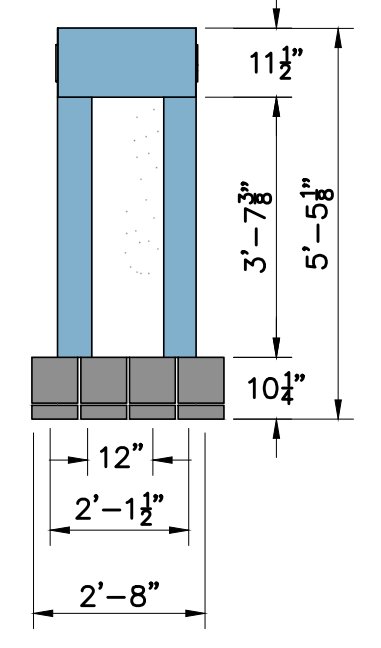

- NOTES:**
- SIGN TO BE PROVIDED/DESIGNED BY EVERBRITE LLC, HEADQUARTERED IN GREENFIELD, WISCONSIN.
  - REFER TO MANUFACTURER'S SPECIFICATIONS FOR MORE INFORMATION.

**MONUMENT SIGN**  
SCALE: NOT TO SCALE

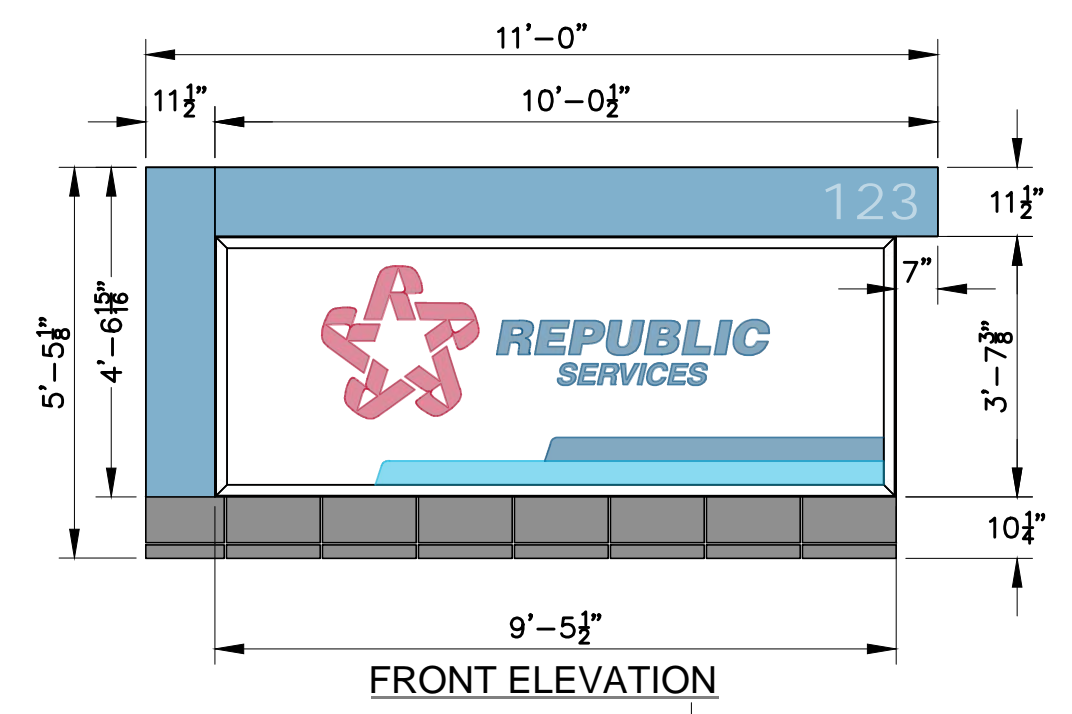
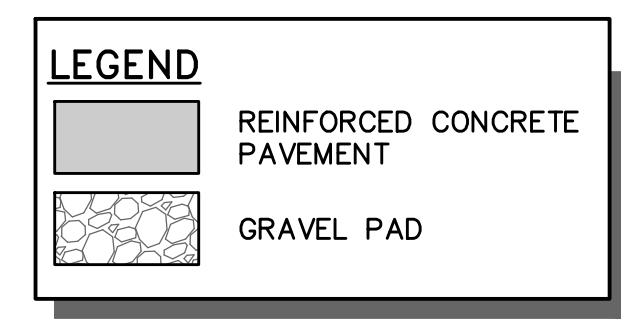
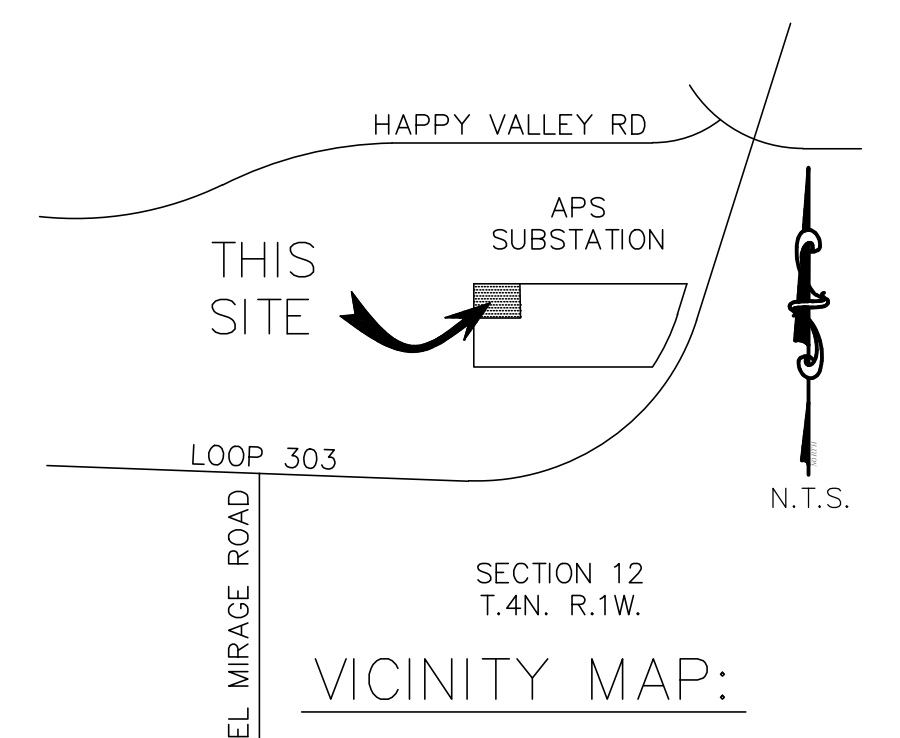
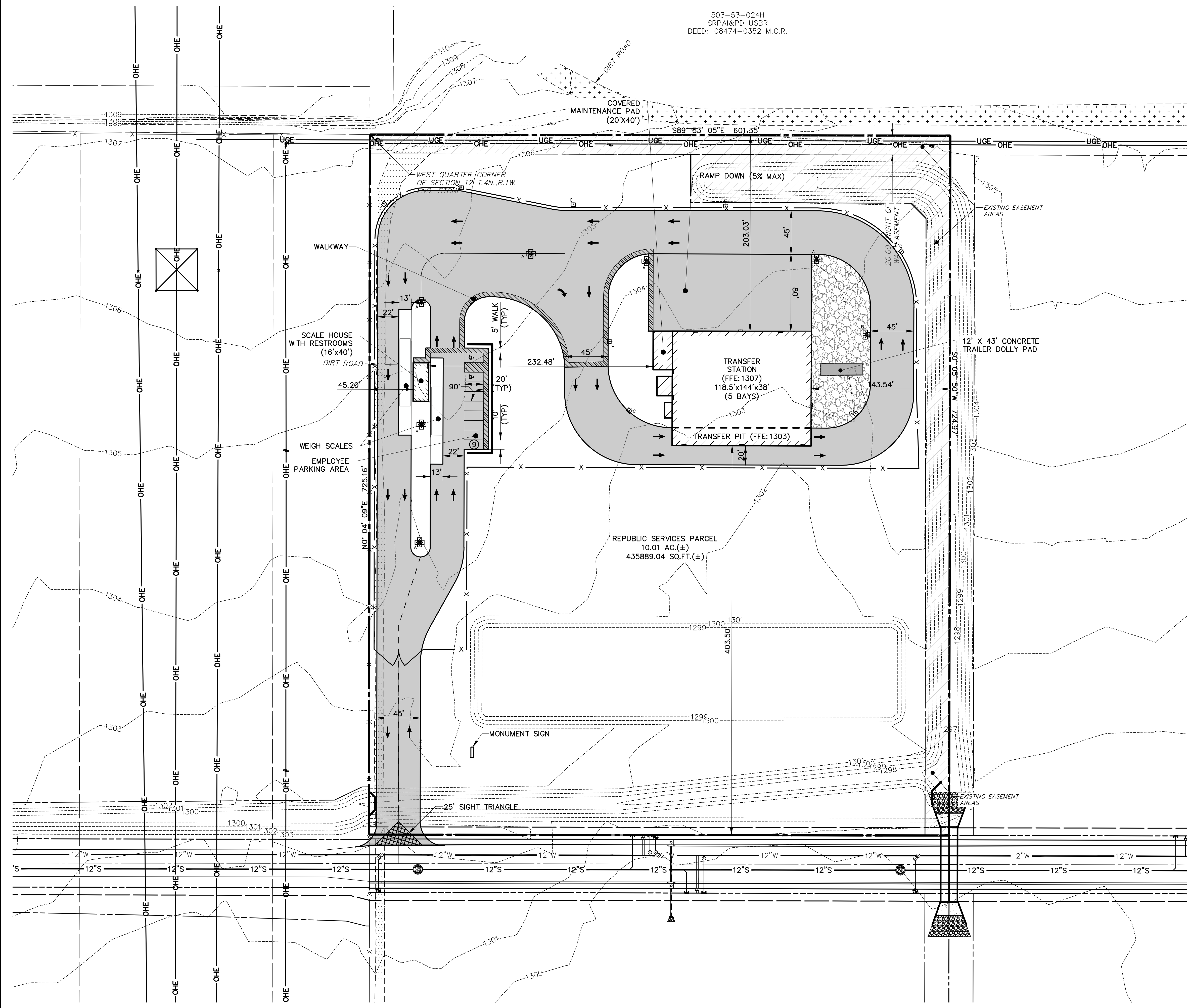
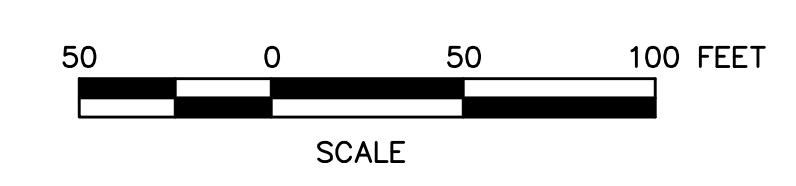
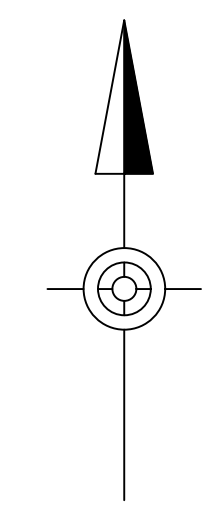

NO.	DATE	COMMENTS

**REPUBLIC SERVICES**  
WEST WING TRANSFER FACILITY  
MARICOPA COUNTY, ARIZONA 85373

**GENERAL DEVELOPMENT PLAN**

DRAWN BY: SAH  
APPROVED BY: CMS

PROJECT NUMBER:  
12189-079

DATE PRINTED:  
02/AUG/2021

SHEET NUMBER:  
**C2**

ZONING SUBMISSION